



apan made products

Linear Motor Drive Precision Metal 3D Printer

OPM350L / OPM250L

Experience Creating the Future



The new shape is made with grown technology.

New Creat New Form.

Create your future with Sodick precision metal 3D printer.



OPM350L & OPM250L

The Sodick "OPM Series" OPM250L and OPM 350L precision metal 3D printers are an innovative manufacturing system capable of producing one-piece metal molds, fundamentally changing how molds for plastic products are created.

With enhanced productivity, reduced lead times, and substantial cost reduction for molded products, the system achieves levels of performance not possible on conventional production systems. Moreover, the OPM250L and the OPM350L come prepared for integration with the Internet of Things (IoT) to allow unmanned and automated production at the manufacturing site. Designed to permit remote operation, the system significantly reduces labor costs by streamlining the production process.

Sodick Group is committed to expanding its core technologies for all processes to offer one-stop solutions, following our tradition of "Creating What We Cannot Find in the World."



tion,

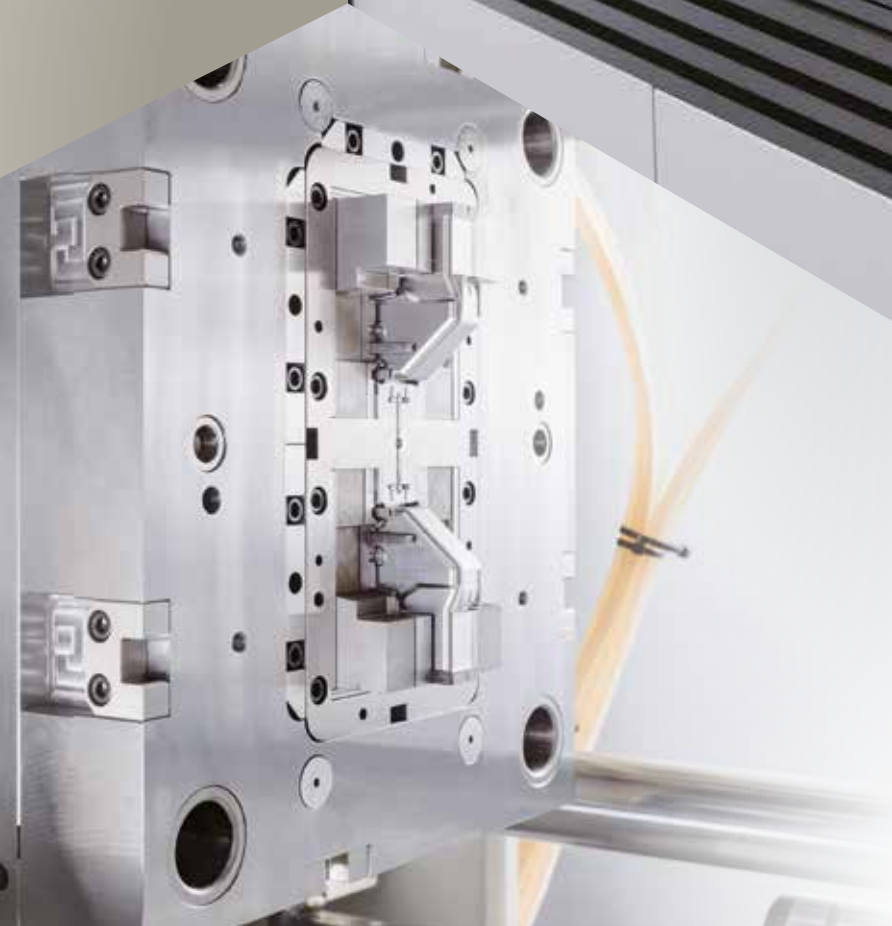



One Stop Solution

Machining Center

In addition to our proven linear motor and high-speed milling technologies, the UH Series offers practical machining simulation software and an ergonomic, curved design. Through full linear motor operation, Sodick machining centers achieve high-speed, high-precision, high-quality machining.



Sodick proudly introduces practical one-stop metal 3D printing solutions.

The OPM Series precision metal 3D printers allow us to offer an industry-leading “one-stop solution.” Sodick provides integrated support for all processes, from design to molding, through its extensive technologies, including wire-cut electrical discharge machines, die-sinker electrical discharge machines, injection molding machines, and machining centers. Performing laser sintering and high-speed milling on the same machine permits the machining of complex molds with a degree of freedom and high-precision finishing that is simply impossible with conventional cutting tools.



Die-Sinker EDM

The new "Arc-less Plus" electrical discharge machining system is installed standard, lowering overall costs and human errors by substantially shortening machining times and reducing the number of electrodes required. Moreover, the SVC circuit rapidly creates high-quality satin or mirror surfaces.

Precision Metal 3D Printer

The OPM Series performs continuous laser machining and high-speed milling in a single machine. A uniform layer of metal powder is melted and solidified through direct metal laser sintering. This is then precision machined by high-speed milling to create a high-quality shape not attainable through additive manufacturing alone.



OPM Series



Wire EDM

Smart Pulse electrical discharge technology and a proprietary direct tension servo mechanism accomplish both high-speed and high-precision machining for unparalleled performance. Additionally, the FJ-AWT high-speed automatic wire threader incorporates a wire straightening function, enabling high wire threading rates. The result is reduced work hours and long-term, unmanned operation.



Injection Molding Machine

Sodick employs the V-LINE® system that separates the plasticization and injection processes. Adopting the proprietary V-LINE® system allows the development of a zero-backflow system. After weighing, the flow is actively cut off before the injection operation is performed, so that all weighed resin is injected into the mold. The introduction of the V-LINE® system brings about accurate filling volumes for more stable molding.

ution

Additive Manufacturing with Sodick's Precision Metal 3D Printer

The OPM Series is an automated machine that melts and solidifies a uniform layer of metal powder in a process called laser sintering. The machines then engage in high-speed milling for highly accurate finishing. Sodick proudly achieves metal 3D printing through the use of a 500W fiber laser for the melting and solidifying metal powder.



Recoating

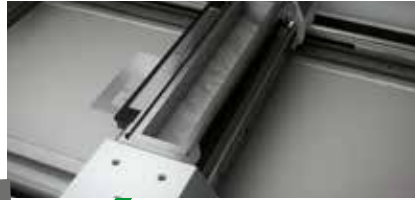

After each layer is fully machined, the workspace is recoated with metal powder and the process is repeated.

Laser machining

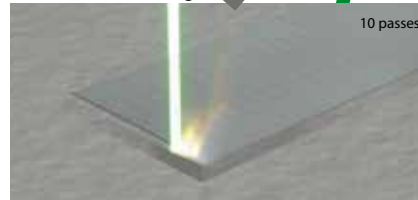

10 passes

Milling is performed after 10 laser machining operations. These operations are repeated to create a 3D printed (layered) workpiece.

[99.9% Melting Ratio]

* The index of the metal filling rate in company regulations

0.05 mm / 1 layer

High-speed milling



1 pass

The OPM Series features a 45000 min⁻¹ spindle that achieves high-speed and high-precision machining with Sodick's non-contact rigid linear motor drives. An automatic tool changer (ATC) and automatic tool length measuring device are installed to allow continuous automated operation over a long period of time.

Metal 3D printing



High Power Laser & High Speed Milli



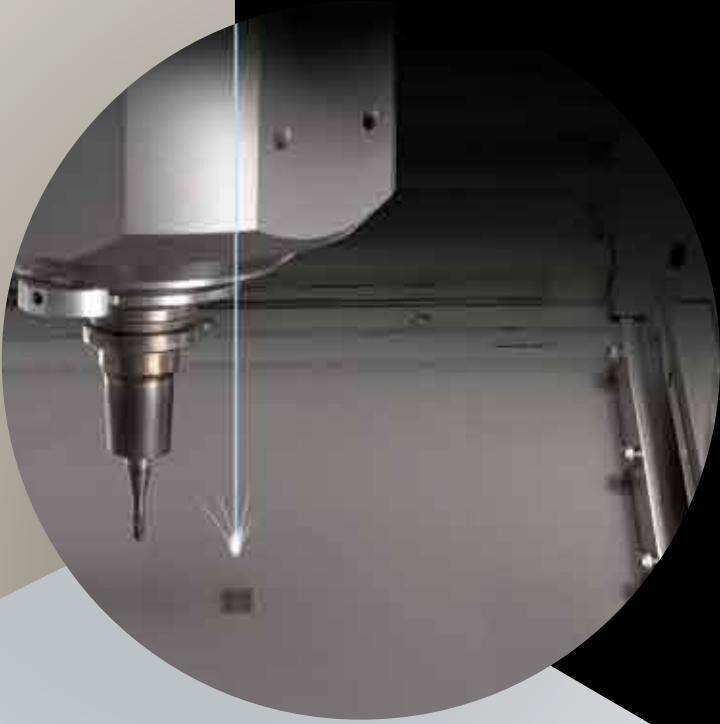

Metal 3D printing intermediate stage



Mold with cooling channels

ng

Sodick In-house Developed and Manufactured New NC Unit and OS-FLASH Dedicated CAM

After designing a mold with 3D cooling channels using CAD software, a plastic temperature simulation is performed using CAE. Next, the optimized 3D CAD data is loaded into the "OS-FLASH" dedicated CAM system, which creates the NC program and directly supplies it to the LN4RP NC unit.

Setup screen



Easily configure the settings before mold manufacturing. Production data can be imported by simple drag and drop procedure.

Laser machining screen



Shows laser machining progress at a glance.

Tool management screen



Acquires tool information from CAM and displays the settings and tool use status.



Sodick Motion Controller

In-house

Accurately controls the linear motor's precision movements according to commands from the NC unit. The K-SMC motion controllers designed and manufactured by Sodick ensure reliable control for high speed, high acceleration, and accurate positioning.

Linear Motors

Sodick employs high-performance linear motors developed and manufactured by Sodick, replacing ball screw drives with a reliable direct drive system. These linear motors indefinitely maintain backlash-free, accurate axis movements, which is impossible with conventional ball screw drive systems. A space-saving machine layout design is achieved by arranging the drive axes for high-speed milling and laser machining in a compact structure.

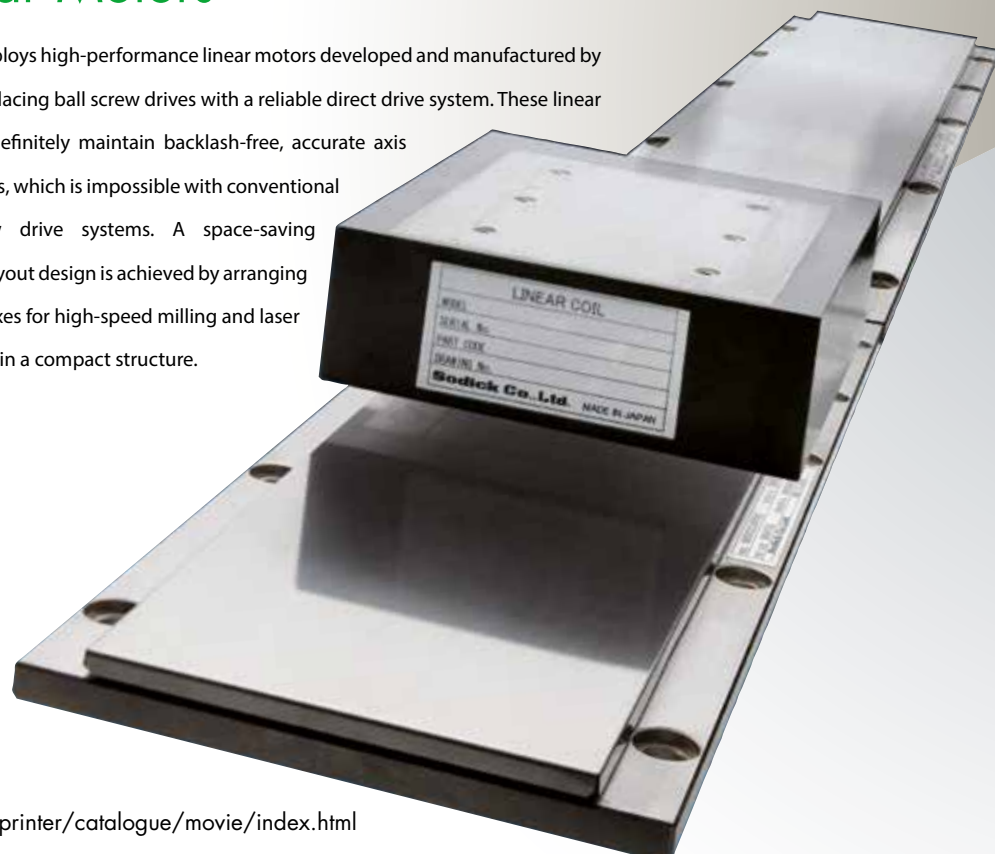

All elemental technologies
developed and manufactured by
Sodick

Core Technology

development of all core technologies



High-Speed Cutting

Sodick has fostered a line of high-speed, high-accuracy cutting technology over the years using high-speed milling center developed in-house. The OPM Series permits stable finishing for a wide range of applications by integrating proven machining expertise with this high-speed milling center.

Chamber Technology

Sodick is an expert in vacuum chamber design, with over 10 years of production experience. First designed in 2003, Sodick's vacuum chamber technology has been tested in the PF00A/PF32A Electron Beam PIKA Finish EBM, with great success. By maintaining a high concentration of inert gas, Sodick's vacuum chamber achieves stable and accurate laser sintering.

Mold Internet of Things (IoT)



Unmanned and Automated Control, Remote Operation

The expertise of experienced engineers was indispensable for conventional mold manufacturing, which required complex processes, numerous parts, and multiple machine tools. Today, however, the OPM Series may be the only machines that encompasses a full production system to manufacture high-density, finished molds with one-piece construction. With high-quality mold data, the OPM Series allows for unmanned manufacture of high-quality molds anywhere. It is easy to create a "Mold Internet of Things" to control production from a remote design department.

The result is automation with reduced lead times, lower costs, and significant labor savings. In this way, the manufacture of uniform quality products in any location can be achieved.

Security Measures

Sodick NC units apply the following security measures to the network connections.

LN4RP power supplies offer:

- System protection with the FBWF (File-Based Write Filter) function
- Prohibited execution of files other than CNC system files;
- Data communication between power supply and external PC using FTP;
- Prohibits connections, except to Sodick-certified USB memory



High-Quality Machining to Create Mold IoT

Mold manufacture requires a high sintered density (99.9% melting ratio) and highly accurate machining. The OPM Series meets both criteria, permitting finishing (SPI-A2 class) not possible with a conventional metal 3D printer.



After buffing Ra 14 nm

Test Machining to Check Accuracy

Required precision of $\pm 1/100$ mm in maraging steel
All shapes were achieved.

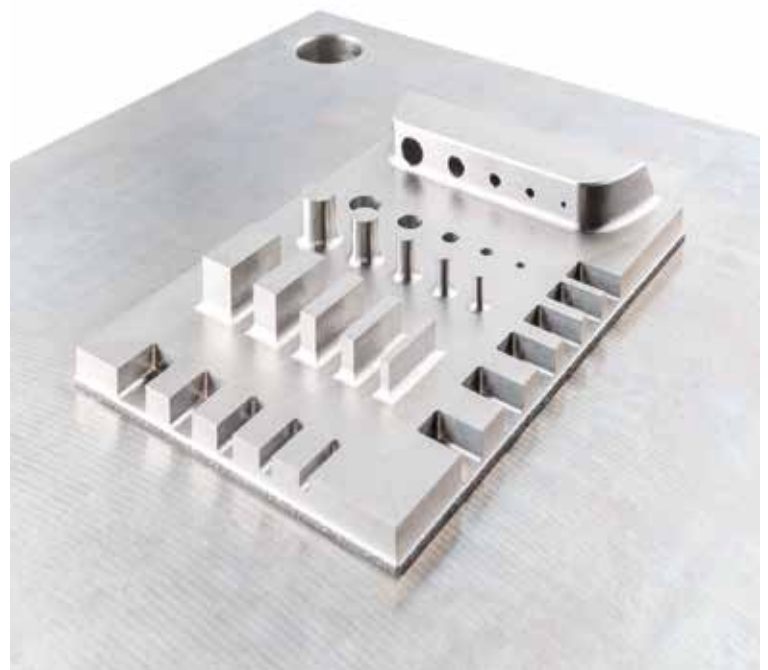
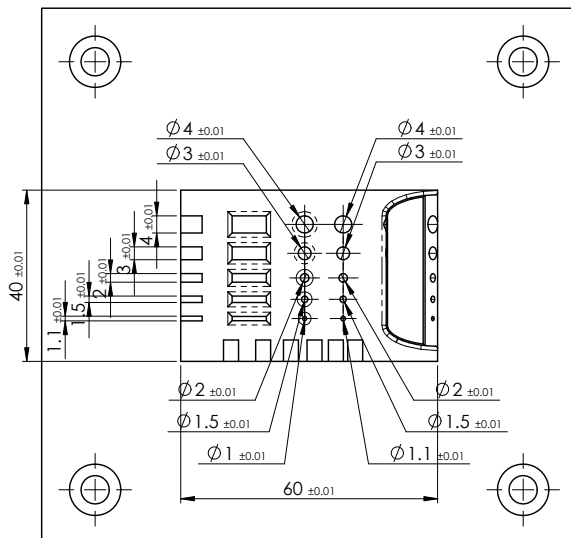

OPM Series: Plastic Molding Rev

(OPM250L / OPM350L)

3D modeled cooling channels

Product 3D data

Procedure

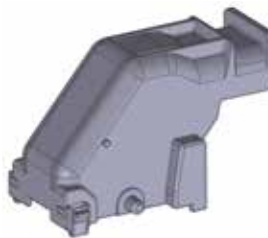
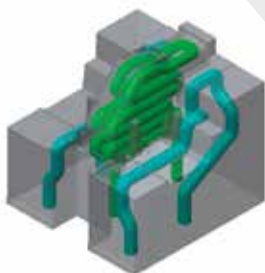

Investigate mold design
Propose areas of improvement

Uniform, high-quality production control (mold IoT) from a remote location

High-precision machining of freely configured, one-piece molds

1

Moldex3D plastic injection molding simulation software (Core Tech System Co., Ltd.) permits the 3D arrangement of cooling channels which can normally be arranged in two dimensions only. It also performs simulation of molded products during injection molding. Side-by-side comparisons with conventional molds confirm that deformation is lower with the 3D cooling channels.

Conventional mold: 2D cooling channels

As cooling channels can only be arranged in two dimensions
...low degree of freedom

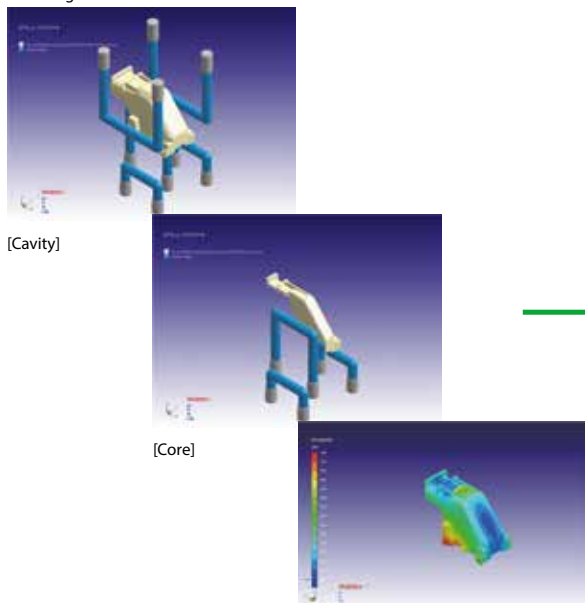

OPM mold: 3D cooling channels

As cooling channels can be arranged in three dimensions
...high degree of freedom

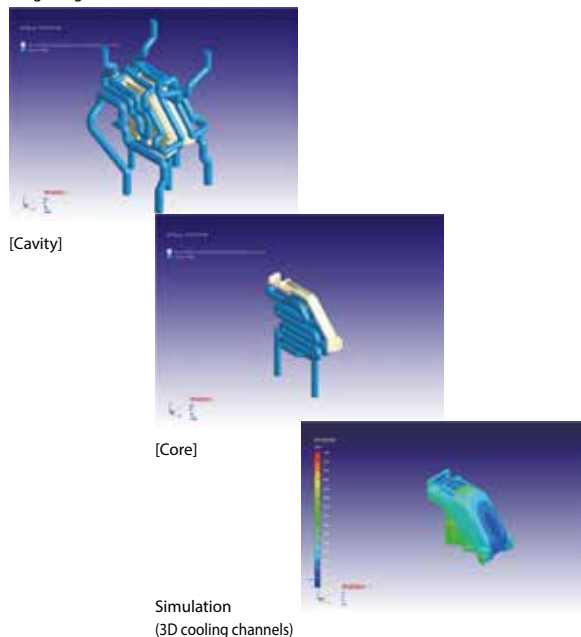

- Deformation must be estimated for mold production.
- The estimated deformation may result in a reverse gradient in the direction of product withdrawal.
- A slide mechanism may be required in the mold construction.

- As a 3D arrangement of cooling channels is possible, molds can be produced without estimating the deformation. A one-piece mold can be produced instead of a divided mold.
- Mold production is simple, as no slide mechanism is required in the mold construction.

olution

When plastic products are injection molded, the molding performance is significantly affected by the construction of the mold used. Temperature control inside the mold is always a critical element in this aspect. The OPM Series can produce molds with 3D cooling channels freely positioned inside, eliminating uneven temperatures within the mold. It allows an ultra-high cycle rate that was impossible with a conventional mold and permits optimization of the molding shrinkage. As a bonus, these process improvements reduce the lead time by half or more.

Cooling channel design

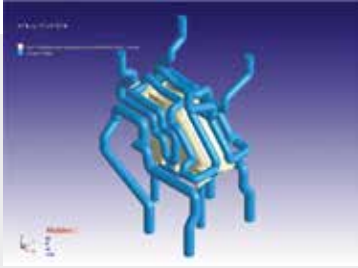

Simulation

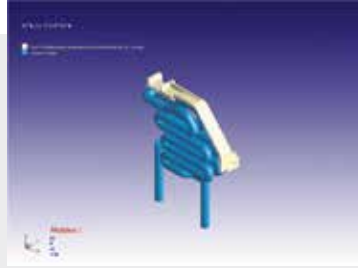

Alteration

Determine most efficient cooling channels



OPM mold design
Overall construction

Reduced total costs

Shorter lead times

2

Suppresses the deformation of the molded products by allowing conventional split molds to be made as one piece, achieving an optimal cooling channel arrangement that was not possible with conventional machine tools.

Conventional mold: 2D cooling channels

Cavity (Front) 21 parts

Part name	Part number	Amount
Front Insert	10100	2
Front Insert	10200	1
Front Insert	10300	1
Front Insert	10400	2
Front Insert	10500	1
Front Insert	10600	1
Front Insert	10700	1
Front Insert	10800	1
Front Insert	10900	1
Front Insert	11000	2
Front Insert	11100	2
Front Insert	11200	1
Front Insert	11300	1
Front Insert	11400	2
Front Insert	11500	2
Rear Insert	50100	1
Total		21

Core (Rear) 31 parts

Part name	Part number	Amount
Rear Insert	50100	1
Rear Insert	50200	2
Rear Insert	50300	2
Rear Insert	50400	2
Rear Insert	50500	1
Rear Insert	50600	1
Rear Insert	50700	2
Rear Insert	50800	2
Rear Insert	50900	1
Rear Insert	51000	2
Rear Insert	51100	2
Rear Insert	51200	1
Rear Insert	51300	1
Rear Insert	51400	1
Rear Insert	51500	2
Rear Insert	51600	2
Rear Insert	51700	2
Rear Insert	51800	2
Rear Insert	52000	1
Rear Insert	52100	1
Total		31

OPM mold: 3D cooling channels

Cavity 1 part

Core 2 parts

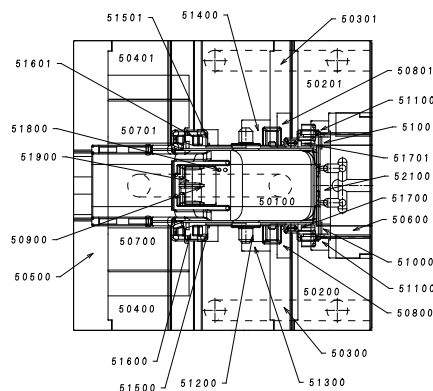
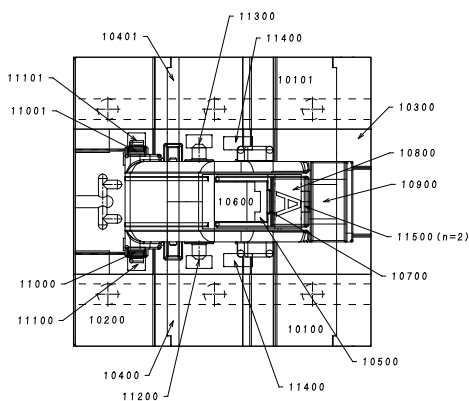

Cavity and core design for OPM

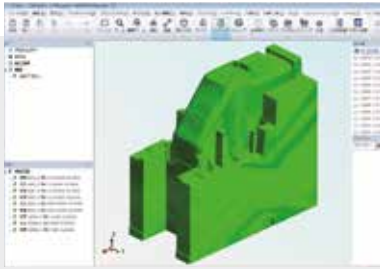

Programming

OPM machining



Precision Metal 3D Printer OPM Series

OPM mold post-processing



Wire EDM

Significant Reductions in Mold Production Lead Time

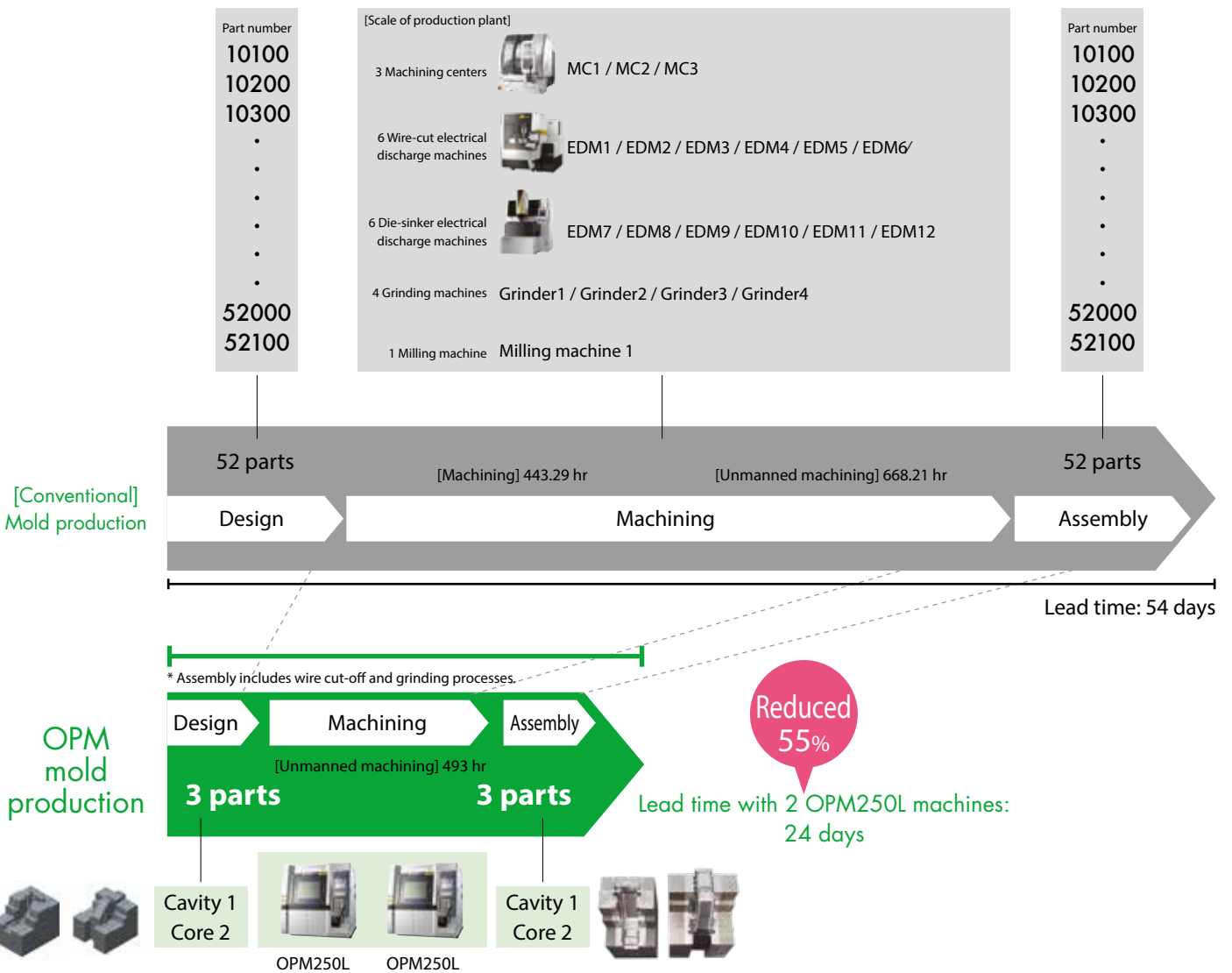

Japan made products

Mold assembly

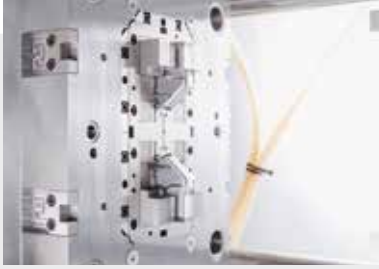

Injection molding



Injection molding machine

Completed products



Comparison of Deformation of Molded Products

With the cooperation of **Sodick F.T**
Future Technologies

[AIM] To check the deformation of openings using 3D cooling.
[TEST DETAILS]
Comparison of conditions: mold temperature 50°C + logic temperature 50°C

Design stage

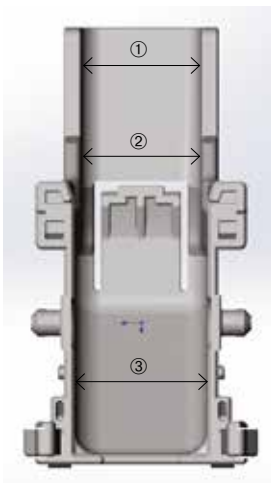

[Conventional mold]

Estimated deformation

- ① 0 mm
- ② 0.8 mm
- ③ 1.2 mm

Due to 2D cooling channels, deformation must be estimated when making the design

[OPM mold]

Estimated deformation

- ① 0 mm
- ② 0 mm
- ③ 0 mm

Due to optimal 3D cooling channel arrangement, design with zero deformation is attainable

Measured deformation values



[Conventional mold]

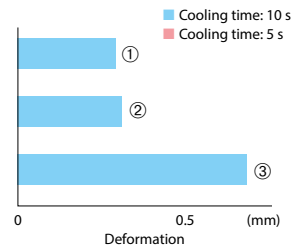

[OPM mold]

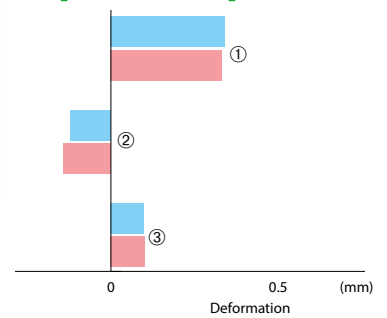

Deformation estimation not required
Simpler mold shape
Permits sophisticated shapes

Efficient cooling shortens molding cycle
Achieves 5 s cycle time

Shorter time
Cost reduction
Contributes to factory productivity

EV Connector

To improve cooling around the central ribs, the cooling channels are arranged to surround these areas. The interior of the cooling channels are machined to enhance surface roughness and an adequate volume of cooling medium flows through the 1.2 mm diameter channels. All machining can be performed by a single process on the OPM250L, including the many ribs arranged around the perimeter.

DATA Machine used: OPM250L

Mold manufacturing (sintering) time: 15 hr

Cutting time: 28 hr

Total time: 43 hr

Mold size: 60 mm x 40 mm x 40 mm

Material: Maraging steel

Tools: 1 and 2 mm dia. ball end mills

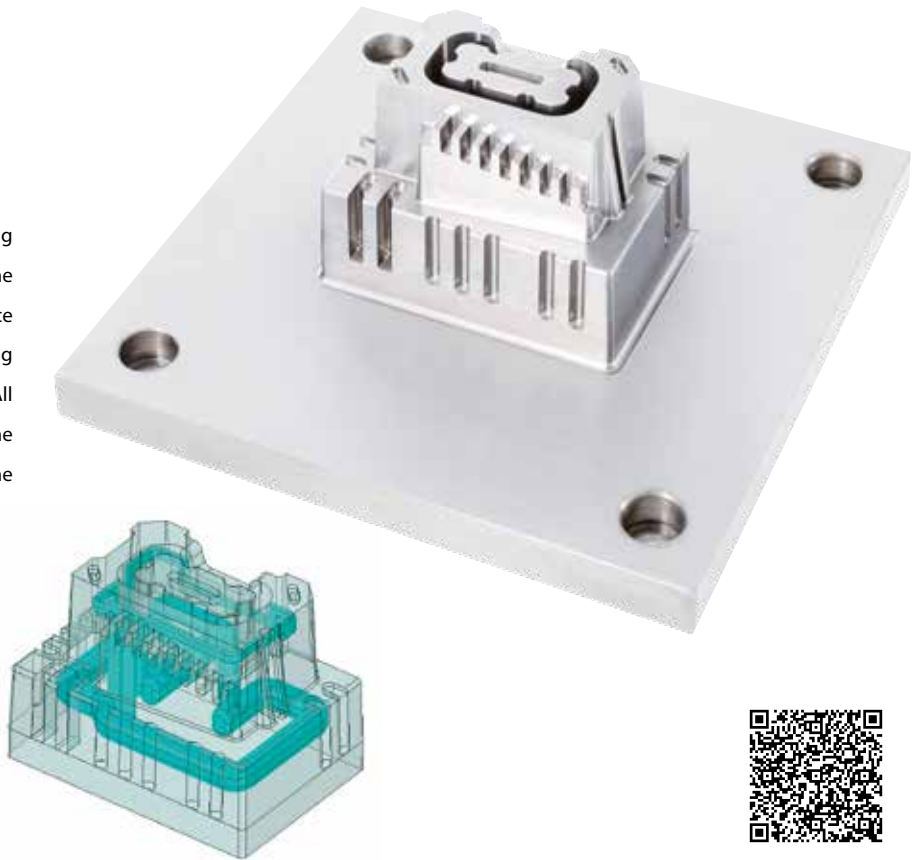

http://www.sodick.co.jp/product/tool/metal_3d_printer/catalogue/movie/index.html

Switch Box

A spiral cooling channel is placed in the difficult-to-cool protrusion in order to achieve higher cooling efficiency than normal spray or baffle cooling. Additionally, a peripheral cooling channel that uniformly cools the molded product restricts the deformation of the plastic molded product.

DATA Machine used: OPM250L

Mold manufacturing (sintering) time: 17 hr

Cutting time: 25 hr

Total time: 42 hr

Mold size: 120 mm x 70 mm x 73 mm (including the plate size)

Material: Maraging steel

Tools: 1 and 2 mm dia. ball end mills, 1 mm dia. flat end mill



http://www.sodick.co.jp/product/tool/metal_3d_printer/catalogue/movie/index.html

Duct Shape Core

The OPM Series permits the design of spiral cooling channels inside a curved shape, which is impossible to machine with general machine tools. High-precision processing of external shapes, including deep ribs, and machining of the internal spiral structure can be handled on a single machine.



DATA Machine used: OPM250L

Mold manufacturing (sintering) time: 16 hr

Cutting time: 43 hr

Total time: 59 hr

Mold size: 92.1 mm x 36.3 mm x 33 mm

Material: Maraging steel

Tools: 1 and 2 mm dia. ball end mills

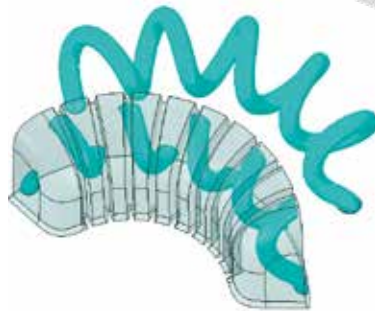

http://www.sodick.co.jp/product/tool/metal_3d_printer/catalogue/movie/index.html

Cylindrical Fin Core

Adequate cooling channels can be designed at the center of a cylinder surrounded by deep ribs to achieve a high cooling effect at the tips. The multiple ribs can only be finished by the OPM250L, which significantly cuts the number of machining processes.



DATA Machine used: OPM250L

Mold manufacturing (sintering) time: 29 hr

Cutting time: 67 hr

Total time: 96 hr

Mold size: 79.6 mm x 39.8 mm x 61 mm

Material: Maraging steel

Tools: 1 and 2 mm dia. ball end mills, 1 and 4 mm dia. flat end mills



http://www.sodick.co.jp/product/tool/metal_3d_printer/catalogue/movie/index.html

Importing Model Data

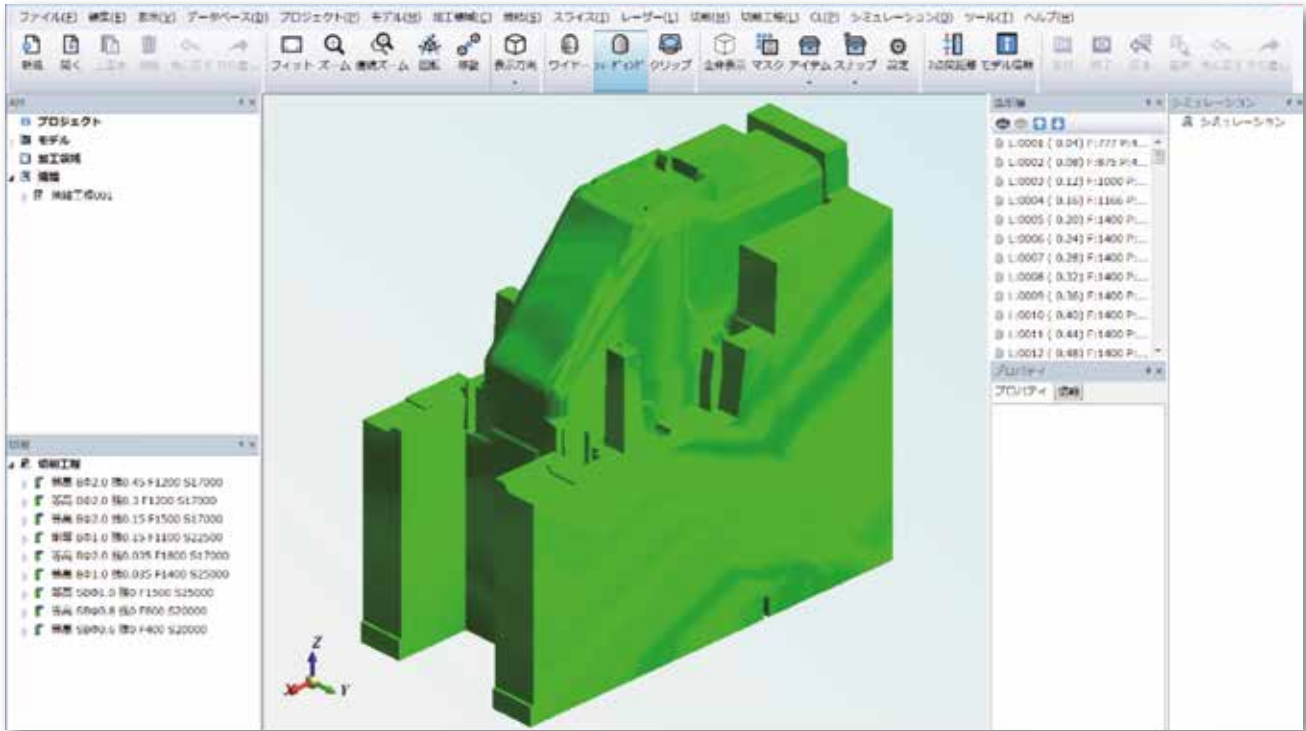

OS-FLASH is a dedicated CAM system for the OPM Series. The system inputs CAD data such as IGES, STEP, and Parasolid to create the laser and cutting data. Unique algorithms attain rapid calculations to create high-accuracy cutting passes.



Specialized parameter settings for compound machining

CAD interface

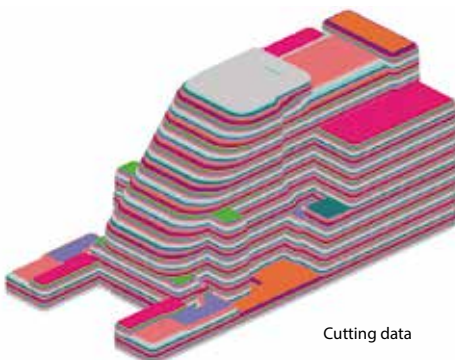

Cutting data

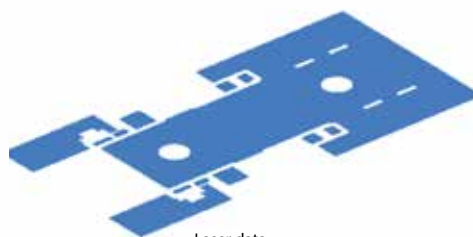

Laser data

Creating Laser Data

By applying a 3D offset to the input 3D model, various laser data can be created, such as the two-layer structure consisting of melt parts and core parts, as well as sintering methods that create a chessboard pattern. Laser data can also be created for the STL file, allowing for the manufacture of scanned data.

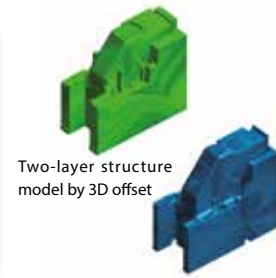
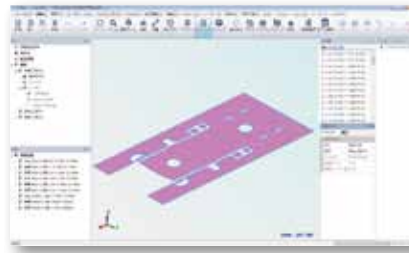

Two-layer structure model by 3D offset

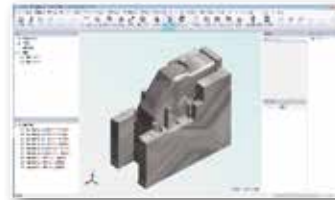

STL model compatible



Laser-type [chessboard pattern]

Optimizing Cutting Data

Sophisticated and rapid editing can be performed to optimize the cutting data and reduce the cutting time and cutting loads.

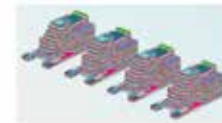
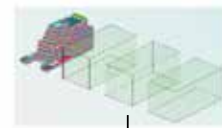
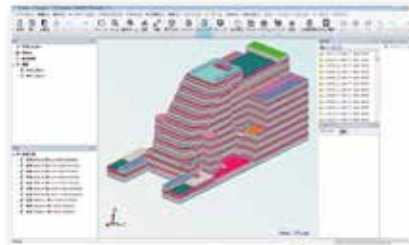

Rapid editing functions

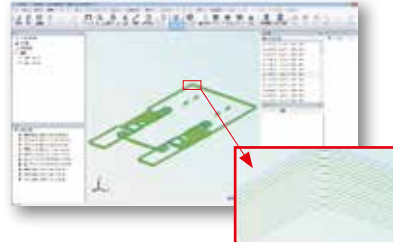

Areas of high load, such as grooves and corners, are automatically detected and the feed rates automatically adjusted



Function to change feed rate in a specified area

Simulation

The cutting simulation function can be used to confirm unmachined and excessively cut sections. The mold manufacturing time calculation function calculates times by considering the movements of the machine to allow appropriate process management.

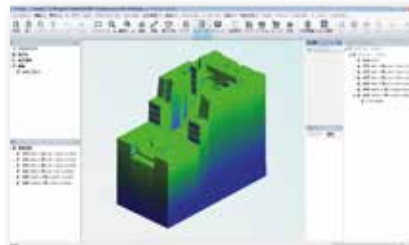

Cutting simulation function

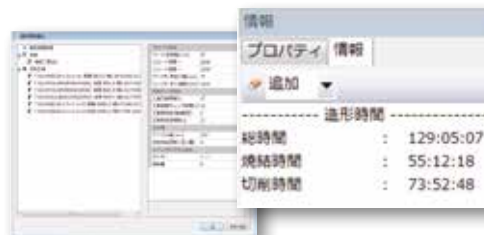

Calculating mold manufacture estimated times



OPM350L (With optional MRS unit)



High-speed spindle, CCD camera

Features a 45000 min⁻¹ spindle for high-speed milling.
A CCD camera is used for laser positional correction.



OPM250L



Nitrogen gas generator

Supplies nitrogen gas to the machining area.



Wide-open operation door

By adopting the wide-open operation door, both pre-setting before forming and after-maintenance becomes easy.

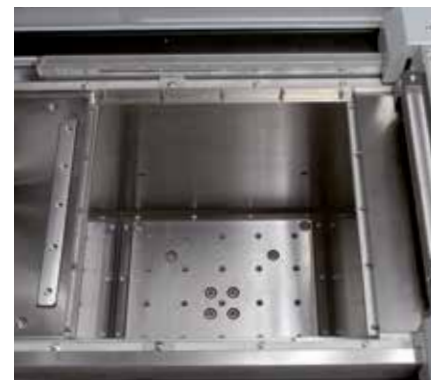

Machining table

Offers mechanisms to secure the base plate for laser sintering and set the base plate to the required height.



Automatic tool changer (ATC)

A device that automates the exchange of tools between the spindle and magazine. Up to 16 tools can be set in the magazine. (* Up to 20 tools for OPM350L)



Automatic tool length measuring device

Device to measure the distance between the spindle reference plane and tool tip.



Tool replacement area

The area where the tools are set in the automatic tool changer (ATC) magazine.



Yb fiber laser (500 W)

Provides laser irradiation to sinter the metal powder.

Exhaust port

Exhaust port for the machining area.

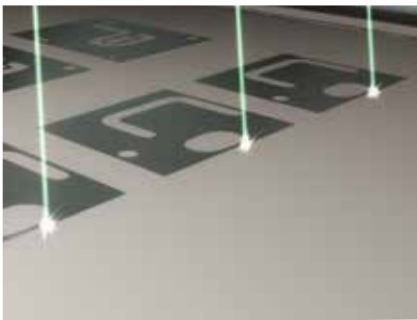

Parallel Mode Function

The OPM Series comes with a parallel mode function, enabling simultaneous laser sintering of multiple locations by controlling a single laser at high speed.

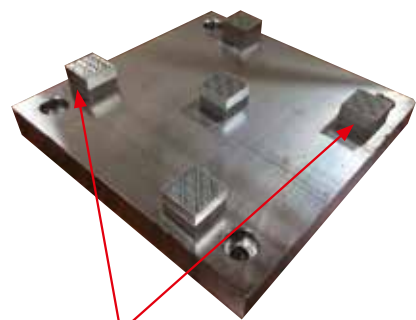

Entire surface cutting

In-process compensation

Automatic compensation that measures and identifies alignment errors/positional deviations of the laser and the main spindle during machining.



Material Recovery System

Sodick has developed an optional MRS (Material Recovery System) unit to enable fully-automated metal 3D printing and milling of larger workpieces.

OPM250L

Specifications

Dimensions

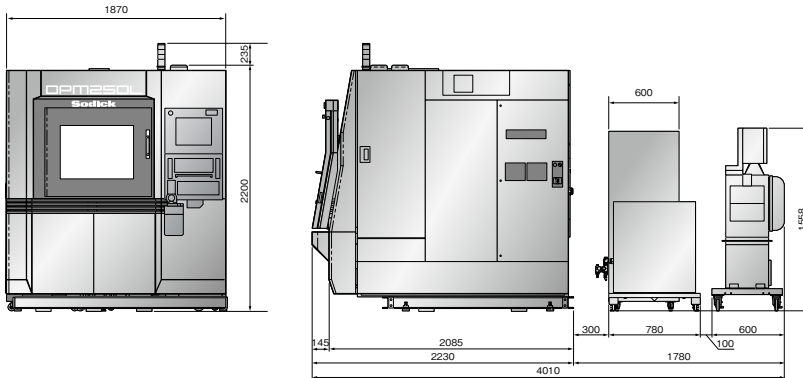

Layout

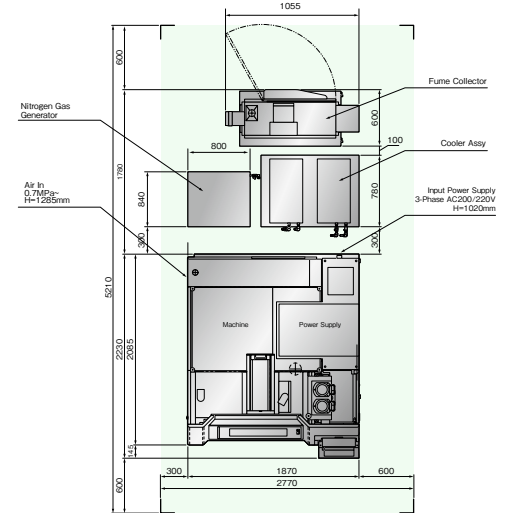

Unit: mm

Machine Specifications

Max. object size (Width) × (Depth) × (Height)	250 × 250 × 250 mm
X-axis travel	260 mm
Y-axis travel	260 mm
U-axis travel	260 mm
Machining tank internal dimensions (Width) × (Depth)	290 × 290 mm
Spindle Z-axis travel	100 mm
Max. workpiece loading weight	100 kg
Nitrogen supply capacity	90 NL/min
Machine tool dimensions (excluding peripheral devices)	1870 × 2230 × 2200 mm
Machine tool weight (excluding peripheral devices)	4500 kg

Laser

Laser type	Yb fiber laser
Laser wavelength	1070 nm
Max. laser output	500 W
Laser scanning	Galvano method

Spindle / Automatic Tool Changer

Max. spindle rotation speed	6000 to 45000 min ⁻¹
Max. spindle torque	0.8 Nm
ATC tool holders	16
Tool holder system	Dual-contact shrink fit holder HSK-E25

Metal Powder

OPM ULTRA1 (Maraging Steel)
OPM SUPER STAR (SUS420J2)
OPM Stainless 316
OPM Stainless 630

LN4RP NC Unit

Control axes	6 axes (X, Y, Z, U, B, Spindle)
Simultaneous control axes	Max. 4 axes
Minimum input command	0.1 μm
Minimum drive unit	0.031 μm

The dielectric chillers on Sodick machines contain either fluorinated greenhouse gas R410A or R407C.

* Metal powders for use in the OPM Series. For details, contact the sales department.

Options

- MRS unit
- 3-light signal tower
- External transformer
- 100 VAC outlet
- Air dryer (primary side)
- Air tank
- Material-restricting bellows (rectangular type)
- 3-phase input cable
- Shrink fitting device (Heat Robo)
- Base master
- Point master
- Set of pin cushion parts
- Power sifter (unnecessary when using MRS unit)
- Sifter (unnecessary when using MRS unit)
- Sifter tray lid set (unnecessary when using MRS unit)
- Laser eye protection
- Filter replacement dust mask
- Filter replacement dust mask filters
- Tool cutter
- Demagnetizer
- Magnetic flux density meter
- Vertical probe (for magnetic flux density meter)
- Industrial vacuum cleaner (for metallic powder; unnecessary when using MRS unit)
- Silent cleaner (for fume cleaning)
- High-power cleaner (for floor cleaning)
- Initial processing tool set
- Laser inspection
- USB memory
- Large container (for fume collector cleaning)

OPM350L

(With optional MRS unit)

Specifications

Dimensions

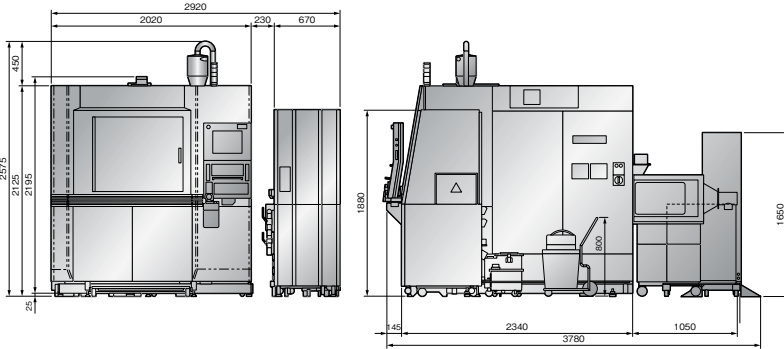

Layout

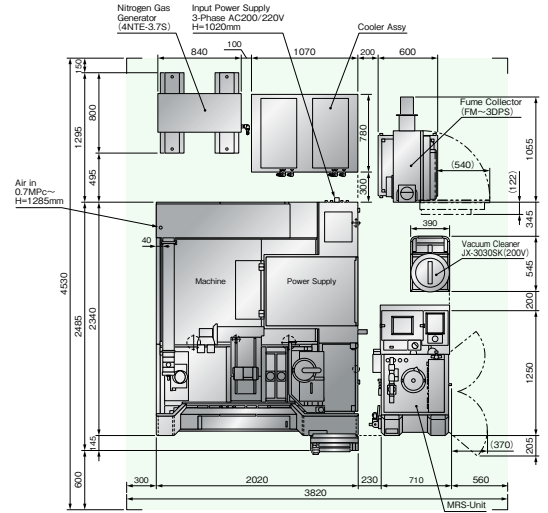

Unit: mm

Machine Specifications

Max. object size (Width) × (Depth) × (Height)	350 × 350 × 350 mm
X-axis travel	360 mm
Y-axis travel	360 mm
U-axis travel	344 mm
Machining tank internal dimensions (Width) × (Depth)	390 × 390 mm
Spindle Z-axis travel	100 mm
Max. workpiece loading weight	300 kg
Nitrogen supply capacity	90 NL/min
Machine tool dimensions (excluding peripheral devices)	2020 × 2485 × 2220 mm
Machine tool weight (excluding peripheral devices)	5800 kg

Metal Powder

OPM ULTRA1 (Maraging Steel)
OPM SUPER STAR (SUS420J2)
OPM Stainless 316
OPM Stainless 630

The dielectric chillers on Sodick machines contain either fluorinated greenhouse gas R410A or R407C.

* Metal powders for use in the OPM Series. For details, contact the sales department.

Laser

Laser type	Yb fiber laser
Laser wavelength	1070 nm
Max. laser output	500 W (1000 W specification optional)
Laser scanning	Galvano method

Spindle / Automatic Tool Changer

Max. spindle rotation speed	6000 to 45000 min ⁻¹
Max. spindle torque	0.8 Nm
ATC tool holders	20
Tool holder system	Dual-contact shrink fit holder HSK-E25

LN4RP NC Unit

Control axes	6 axes (X, Y, Z, U, B, Spindle)
Simultaneous control axes	Max. 4 axes
Minimum input command	0.1 μm
Minimum drive unit	0.031 μm

* Only Sodick-specified metallic powder materials can be used.

* Some metallic powder materials require the use of a Sodick-recommended base plate.

* Use of the OPM Ultra 1 or OPM Stainless 316/630 metallic powder materials requires a work environment conforming to health and safety laws (in Japan, the Ordinance on Prevention of Hazards Due to Specified Chemical Substances of the Safety and Health Law).

- Fume collector electrode (spare)
- Activated carbon (for replacement)
- Sintered metallic element (spare)
- Protective synthetic quartz glass (spare)
- Slide seal A (spare)
- Blade acute (spare)
- Blade acute (ceramic)
- Fume collector activated carbon catalyst
- Three-in-one multi dry filter (standard on overseas models)

- The export of Sodick's products and its related technologies (including software applications) is regulated under Japan's Foreign Exchange and Foreign Trade Control Law. The re-exporting of some products is subject to the U.S. Export Administration Regulations (EAR). Consult the relevant Sodick sales personnel before exporting or offering a product outside Japan.
- This catalogue contains a photographic image that has been generated from 3DCG.
- The photographic images in this catalogue may contain optional features, equipments, and accessories.
- Due to constant research and development work, the specifications may be changed without notice.
- The information in this catalog is current as of March 2017.



create your future

Sodick Europe Ltd.

Agincourt Road
Warwick, CV34 6XZ
United Kingdom

Sodick Contact

Phone +44 (0) 19 2669 8888
email europe@sodick.eu.com
online www.sodick.org